

Warewashing



Glass and dishwashers **ECOMAX 404 / 504**



Installation and Operation Manual

(Original operation manual)

EN

Table of Contents

1	Notes on the documentation	4
1.1	Application.....	4
1.2	Layout of the documentation.....	4
1.3	Representation conventions.....	4
2	Safety instructions and regulations	5
2.1	Safety instructions and warning notices.....	5
2.2	Basic safety instructions.....	6
2.3	Property damage.....	7
3	Product description	7
3.1	Intended purpose.....	7
3.2	Designation	8
3.3	Technical data.....	8
4	Controls	8
5	Installation	9
5.1	Special safety instructions.....	9
5.2	Transporting to the installation location.....	9
5.3	Removing the packaging	9
5.4	Installing the machine	10
5.5	Connecting to the power supply.....	10
5.6	Connecting the water	10
5.7	Connecting the drain.....	11
5.8	Retrofitting chemical suction lances with low-level sensors (optional).....	12
6	Commissioning	12
6.1	Setting the water hardness (optional).....	12
6.2	Filling the salt reservoir (optional).....	12
6.3	Prepare chemical suction	13
6.4	Tank	13
7	Operation	14
7.1	Special safety instructions.....	14
7.2	Notes for optimum wash results.....	14
7.3	Preparations for washing.....	14
7.4	Displaying and selecting the program	15
7.5	Washing.....	16
7.6	Switching off the machine.....	16
7.7	Executing daily cleaning	17
7.8	Executing weekly cleaning	17
7.9	Executing hygiene cleaning (only with drain pump).....	17

8	Settings	18
8.1	Overview of operator menu	18
8.2	Open operator menu and make settings.....	18
8.3	Detergent/dosage amount	20
8.4	Rinse aid/dosage amount	20
8.5	Set water hardness	20
8.6	Wash cycles	21
8.7	Hose filling detergent	21
8.8	Hose filling rinse aid	22
8.9	External water treatment.....	22
8.10	Temperatures.....	24
8.11	Displaying the temperatures.....	24
9	Display of faults and information	25
9.1	Information	25
9.2	Error.....	25
10	Troubleshooting guide	26
10.1	Poor wash result.....	26
10.2	Other faults.....	27
11	Maintenance	27
12	Disposal	28
13	Product disclaimer	28
14	Conformity	29

ECOMAX 404 / 504

Notes on the documentation

1 Notes on the documentation

1.1 Application

This document contains the most important information for the installation and commissioning of the machine by qualified personnel, as well as the information required for day-to-day operation by the operator.

- ▶ Keep the operation manual and all referenced documents in a safe and accessible place.
- ▶ Store the operation manual in a suitable container protected from humidity and dirt deposits.
- ▶ If you sell the machine, pass on the installation and operation manual.

1.2 Layout of the documentation

Referenced documents are all instructions that describe the installation, operation, maintenance and repair of the device, as well as additional instructions for all accessories used.

For the operator:









- Operating instructions

For the specialised tradesman:

- Installation instructions
- Circuit diagram
- Spare Parts Catalogue

1.3 Representation conventions

1.3.1 Symbols used

Symbol	Meaning
	Beware of hazardous electrical voltage
	Beware of explosion
	Beware of crushing
	Beware of hazardous substances
	Beware of hand injuries
	Beware of slipping
	Beware of hazard area
	Useful additional information and tips

1.3.2 Representation in the text

Representation	Meaning
NOTE	Important note for the operation of the machine, not a warning notice
▶	Step
↳	Outcome/result
–	Listing 1nd level
•	Listing 2nd level

2 Safety instructions and regulations





2.1 Safety instructions and warning notices

- ▶ During machine operation, observe the general safety instructions and warning notices that precede each action.

2.1.1 Hazard levels

The hazard level is part of the safety instructions and is indicated by the signal word.

Potential consequences are differentiated by the choice of signal word.

	Imminent danger: results in serious physical injury or death.
	Potentially hazardous situation: may result in serious physical injury or death
	Potentially hazardous situation: may result in minor physical injury
	Potentially harmful situation: may cause damage to the product or other objects

2.1.2 Layout of warning notices

Warning notices are depicted with warning symbols and signal words in the corresponding safety colours.





Nature and source of the hazard

Explanation on the nature and source of the hazard

- ▶ Measures for averting the hazard
- ▶ Additional measures for averting the hazard, where applicable

ECOMAX 404 / 504

Safety instructions and regulations

2.2 Basic safety instructions

2.2.1 Product safety

The machine conforms to state-of-the-art technology and the recognised safety regulations. Nonetheless, hazards may occur.

Operate the machine only in compliance with the operation manual.

All modifications and alterations to the product are reserved for persons authorised by HOBART.

2.2.2 Personnel qualification

- ▶ Observe the regulations on occupational health and safety. Wear personal protective equipment.
- ▶ Carefully read through the Installation and Operation Manual before use.

Activity	User group	Qualification/training
Installation	Qualified personnel	Qualified electrician according to local and national safety regulations or electrician trained by Hobart or Hobart Service.
	Trainees	Only under professional supervision and examination
Commissioning	Qualified personnel	Qualified electrician according to local and national safety regulations or electrician trained by Hobart or Hobart Service.
	Trainees	Only under professional supervision and examination
Work on electrical systems	Qualified personnel	Qualified electrician according to local and national safety regulations or electrician trained by Hobart or Hobart Service.
Work on refrigeration systems	Qualified personnel	Category 1 expert certified in accordance with: <ul style="list-style-type: none"> - Ordinance (EU) No. 517/2014 Article 10 - Implementing regulation (EU) 2015/2067 - Section 5 of the Chemicals Climate Protection Ordinance (ChemKlimaschutzV §5) or a competent refrigeration technician according to local and national safety regulations
Operation	Operating personnel and persons over the age of 14	Only under supervision and after instruction by the operator on the basis of the Operation Manual, instructions on dangers
	Handicapped individuals	The suitability must be assessed by the operator on an individual basis
	Persons up to the age of 13	Persons up to the age of 13 are not suited for machine operation
Maintenance, repair	Qualified personnel	Qualified electrician according to local and national safety regulations or electrician trained by Hobart or Hobart Service.
	Trainees	Only under professional supervision and examination

2.2.3 Product-specific hazards

Avoid body parts being crushed or knocked:

- ▶ Observe the instructions on the packaging for storage, lifting or transporting.
- ▶ Do not reach into the hinge while closing the front door.
- ▶ The machine must be secured against tipping over when set up in a freestanding position.

Avoid risk of explosion:

- ▶ Do not install machine in a potentially explosive location.

Avoid electric shock, fire hazard:

- ▶ Do not allow water to flow over live components.

- Make sure the machine is correctly stored (see frost damage section 2.3).
- Make sure the machine does not overflow when being filled.
- ▶ Do not damage the connection cable while unpacking.
- ▶ Have the machine connected to the power supply by qualified personnel.
- ▶ Have all modifications to the machine carried out by qualified personnel.
- ▶ Do not operate the machine without supervision.

Avoid chemical burns, sensitisation of the skin, poisoning:

- ▶ Wear protective equipment (gloves, safety goggles, protective clothing) when handling chemicals.
- ▶ Use only suitable chemicals. Observe the manufacturer's data.
- ▶ Have chemical sensor system set by authorised trained service technicians.
- ▶ Do not open the machine during operation, wait for the program to finish.
- ▶ Disconnect the machine from the mains prior to cleaning.
- ▶ For cleaning, wear protective equipment (gloves, safety goggles, protective clothing) when touching parts contaminated by detergent.

Avoid burns, scalds (to the hands):

- ▶ Do not open the machine during operation or the evaporation phase, wait for the programme to finish. Otherwise, hot water could spray out.
- ▶ Disconnect the machine from the mains prior to cleaning.

Avoid slipping:

Moisture can build up on the floor around the machine.

- ▶ Provide a floor covering that does not pose a risk of slipping when wet.

Residues on the wash ware, hygiene regulations not maintained:

- ▶ Hygiene regulations must be observed and/or demonstrated in accordance with the national provisions.

2.2.4 Additional hazards

Potential hazards caused by operating resources to be used can be found in the enclosed safety datasheets. Workplaces must be marked accordingly.

2.3 Property damage

Avoid frost damage:

Temperatures below 0°C lead to functional damage.

- ▶ Before storing below 0°C, empty residual water in hoses, tank and boiler.
- ▶ Prior to restart, store the machine at room temperature (min. 15°C) for 24h.

Avoid water damage:

- ▶ Do not operate the machine without supervision.
- ▶ Close on-site shut-off valves at the end of operation.

3 Product description

3.1 Intended purpose

The machine is an item of technical equipment intended solely for commercial dishwashing.

The machine is designed solely for cleaning crockery (porcelain, glass, ceramic, temperature-resistant plastics or stainless steel or similar) from the food industry.

Not for washing:

- Containers that do not come into contact with foodstuffs, such as ashtrays, electric appliances etc.
- Animals or textiles
- Foodstuffs intended for further consumption

3.2 Designation

The rating plate is located on the front of the machine. If you have any questions regarding service and parts, quote the serial and DSN No.

3.3 Technical data

Dimensionen (HxBxT)	siehe Aufstellungsplan
Spannung	siehe Typenschild
Gesamtanschlusswert	
Absicherung	
Geräuschemission (Arbeitsplatzbezogener Emissionswert)	Emissions-Schalldruckpegel LpA < 70 dB (A) Messunsicherheit kpA = 2,5 dB
Gewicht	siehe Packstück 

4 Controls

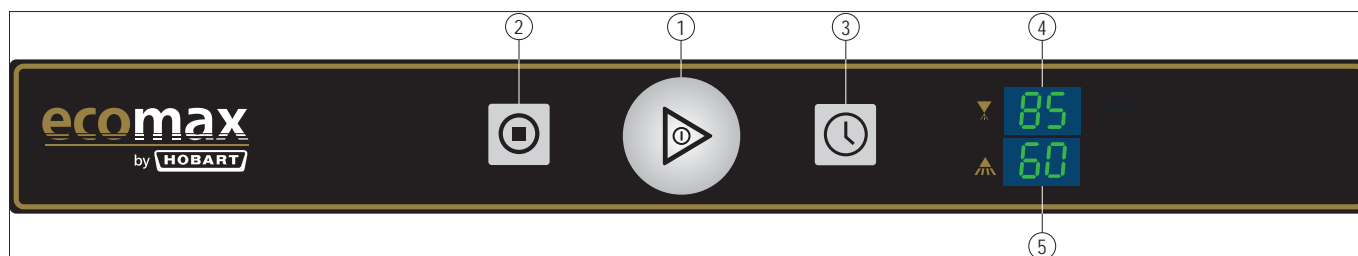

①	ON/OFF key	Pressing this key switches the machine on. Holding the key for 3 seconds activates the automatic drain and self-cleaning programme and switches off the machine. After switch off, however, the machine is not voltage free!
②	STOP key	In case of operating errors or machine faults, this key can be used to switch off the machine immediately without prior drain process. After switch off, however, the machine is not voltage free!
③	Programme selection key	Press the key to choose between different programmes.
④	Temperature display, rinsing	Standard setting shows the maximum temperature achieved during the last wash programme.
⑤	Temperature display, washing	

5 Installation

5.1 Special safety instructions

WARNING!



Risk of electric shock, fire hazard

Frost damage can lead to water flowing over live components and thus to injuries from electric shock or fire.

- ▶ Make sure the machine is correctly stored (see frost damage section 2.3).

CAUTION!



Risk of being crushed or knocked

When being lifted or transported, the machine can overturn or fall and cause injury.

- ▶ Observe the instructions on the packaging for storage, lifting or transporting.

WARNING!



Risk of explosion

Installing the machine in a potentially explosive location can cause explosion and serious injury from ejected parts.

- ▶ Do not install machine in a potentially explosive location.

NOTICE!

Temperatures below 0°C during transport/storage cause function impairments.

- ▶ Prior to installation, store the machine at room temperature (min. 15°C) for 24h.

5.2 Transporting to the installation location

- ▶ If possible, transport the machine in its packaging and on the pallet.
- ▶ Use suitable transport means (elevating truck, crane etc.).
- ▶ If using a forklift, shim the machine with wooden trusses.

5.3 Removing the packaging

CAUTION!



Risk of electric shock, fire hazard

When the machine is unpacked, the connection cable can become damaged and cause injury from electric shock or fire.

- ▶ Do not damage the connection cable while unpacking the machine.

- ▶ Remove packaging materials and accessories from the machine.
- ▶ Inspect the machine for possible transport damage.

ECOMAX 404 / 504

Installation

5.4 Installing the machine

WARNING!



Risk of being crushed or knocked

The machine may tip over when set up in a freestanding position.

- ▶ The machine must be secured against tipping over when set up in a freestanding position.

Wall clearance is not required.

- ▶ Align machine by turning the adjusting feet according to the spirit level.
- ▶ Distribute the machine weight equally onto all feet.

NOTICE!

Property damage

Vapour may escape from the dishwasher door and lead to property damage.

- ▶ Adjacent furniture has to be protected to prevent swelling.

5.5 Connecting to the power supply

WARNING!



Risk of electric shock

Failure to connect properly to the power supply can cause mortal danger from electric shock.

- ▶ Have the machine connected to the power supply only by qualified personnel.
- ▶ Take cable measurement DGUV V3.

NOTE: To guarantee the electrical safety of the machine, it must be connected to a protective earthing equipment conductor installed as specified. In addition, the machine must be connected on site to the equipotential bonding connection. The connecting screw () provided for this purpose is located next to the cable inlet.

These fundamental safety requirements and the professional design of the on-site installation must be verified by a qualified electrician.

Hobart does not accept any liability for damage caused by improper installation! Any applicable local installation instructions must be observed!

The mains cable must be connected via a cut-out device (main switch or accessible plug device).

Modification to an alternative power supply is possible as per the variants on the circuit diagram. Connection diagrams are located adjacent to the connection terminals.

5.6 Connecting the water

NOTE: The machine must be operated with drinking water quality. For water with a high mineral content, we recommend a demineralisation system. In the EU, Switzerland and possibly other countries, a type EA backflow preventer must also be installed at the water connection in order to comply with the requirements of EN 61770 (e.g. HOBART part no. 04-019574-001). Applicable local installation regulations must be observed.

- ▶ If possible, connect to hot water (max. 60°C).

Water hardness:

- Machines without softener: max. 3 °d = 0.5 mmol/l.
- Machines with softener: max. 30 °d = 5.3 mmol/l.

Flow pressure:

- with integrated booster pump: flow pressure 0.8 – 6 bar.
- without integrated booster pump: flow pressure 2 - 6 bar.
- > 6 bar: provide pressure reducing valve.

- ▶ Connect the union nut "A" (3/4" thread) of the water supply hose to the site shut off valve.

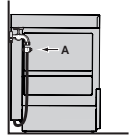

- ▶ Do not kink or cut the water supply hose.
- ▶ Any required extension must be executed using a suitable pressure hose.

5.7 Connecting the drain

Machine without drain pump:

- ▶ Ensure gravity drain.
- ▶ For these machine types, a floor drain is mandatory as the drain hose exits the machine at approx. 60 mm above floor level. Otherwise, residual water may remain in the tank and hose.

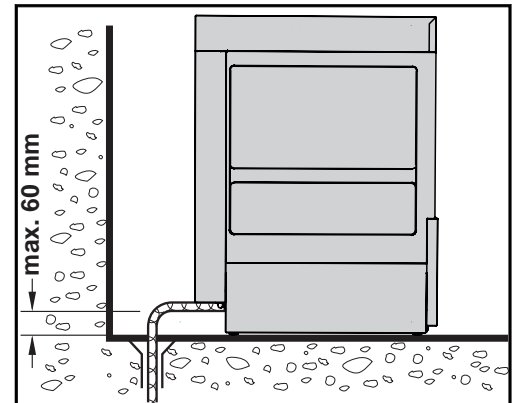

- ▶ Do not kink drain hose.

Machine with drain pump:

- ▶ The connection between machine and site drain must not exceed a max. height of 0.65 m.

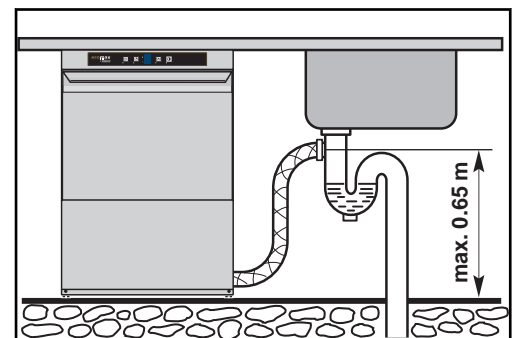

- ▶ Do not lay the drain hose loose on the ground (the hose could become frayed), but fasten it in-situ.
- ▶ Do not kink drain hose.

5.8 Retrofitting chemical suction lances with low-level sensors (optional)

⚠ WARNING!



Risk of electric shock

When touching live parts (hot water tank heater, tank heater, pumps).

- ▶ Have mounted by qualified personnel only.

- ▶ Install according to separate installation instructions.

6 Commissioning

6.1 Setting the water hardness (optional)

NOTE: The softener must be set to the existing water hardness (ask at the local water works).

- ▶ Set hardness range according to section 6.1.

6.2 Filling the salt reservoir (optional)

NOTICE!

Property damage

Accidentally filling the salt reservoir with detergent will damage the water softener.

- ▶ Do not fill the salt reservoir with detergent.

- ▶ Open Door.
- ▶ Unscrew the salt reservoir lid and add approx. 1 kg of granular (2-8 mm) regenerating salt (do not use salt tablets).

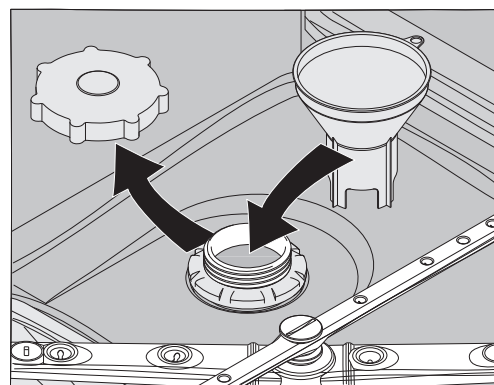

- ▶ Fill up the reservoir with potable water (only during commissioning).
- ▶ Make sure the lid seal is free of soil deposits and salt.
- ▶ Screw lid back on and tighten.

NOTICE!

Property damage

Salt residues on the tank floor cause corrosion damage.

- ▶ Remove salt residues by hand.
- ▶ On completion, start a wash programme to remove all traces of salt, if necessary.

- ▶ If salt deficiency occurs during operation, the top display shows "SA", the bottom display shows "Lt".

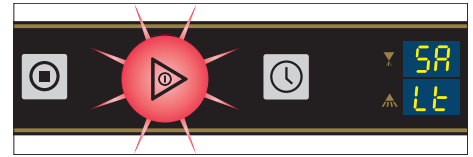

- ▶ To drain water from the tank, see section 7.6.
- ▶ Top up salt (see above). It then takes a few minutes until the display disappears.

6.3 Prepare chemical suction



We recommend the use of HOBART Hyline detergent and rinse aid.

NOTE: Mixing chemicals in the hose when exchanging chemicals can lead to crystallisation and damage to the hoses and dosing units. This is prevented by intermediary rinsing with water (see section 8.7 and 8.8). Failure to comply with this information will invalidate the guarantee and product liability.

⚠ CAUTION!



Chemical burns, sensitisation of the skin, poisoning

Improper use of chemicals or use of unsuitable chemicals can cause injury.

- ▶ Use only commercial detergent and rinse aid.
- ▶ Observe the manufacturer's application and safety instructions.

⚠ WARNING!



Chemical burns, sensitisation of the skin, poisoning

Incorrect handling of detergent or rinse aid can lead to serious injuries.

- ▶ Wear protective equipment (gloves, safety goggles, protective clothing) when handling chemicals.

6.3.1 Provisioning external chemical canisters

Preparing the detergent:

Suction height of dosing pump: max. 1.5 m.

- ▶ Place suction hose **without** colour marking at the suction valve down to the bottom of the external reservoir.

Preparing the rinse aid:

Suction height of dosing pump: max. 1.5 m.

- ▶ Place suction hose with **blue** marking at the suction valve down to the bottom of the external reservoir.

6.3.2 Hose filling

Fill the hose according to the instructions 8.7 and 8.8 .

6.4 Tank

In the case of machines without booster pump that are connected to cold water, we recommend filling and emptying the water tank once according to the instructions (see section 7.3.1 and 7.6).

ECOMAX 404 / 504

Operation

7 Operation

7.1 Special safety instructions

CAUTION!



Chemical burns, sensitisation of the skin, poisoning, burning

If the Door is opened during operation, vapour can escape and/or wash water can spurt out and cause injury.

- ▶ Do not open the Door during operation, wait for the program to finish.
-

WARNING!



Danger of slipping

Moisture can build up around the machine and cause slipping.

- ▶ Provide a floor covering that is guaranteed to be non-slip in case of moisture.
-

7.2 Notes for optimum wash results

The rinse result is significantly affected by the water quality. If the mineral content is high, the minerals dissolved become visible on the glasses in the form of spots and streaks during the drying process.



A HOBART trained service technician can determine the water's mineral content by measuring the electrical conductivity. Values of less than 80 $\mu\text{S}/\text{cm}$ are non-critical for rinsing glasses and cutlery. If the values are higher, we recommend the use of a HOBART HYDROLINE demineralization cartridge or a reverse osmosis unit.

If you have any questions, please contact your authorised HOBART service partner.



We recommend the use of special HOBART glass racks. HOBART racks hold the glasses in slightly inclined positions – this improves the rinse efficiency.

To avoid unpleasant smelling glasses, only chlorine-free detergent should be used for washing the glasses.

Before washing new glasses the first time with a commercial glass washer, intensive basic cleaning is mandatory to reduce the greasy film which is on most glasses for protection during production. We recommend this basic clean is carried out by hand (wear gloves) with a higher detergent concentration (minimum 10 g/l) in a sink using a brush.

7.3 Preparations for washing

7.3.1 Preparing the machine

- ▶ Check correct position of wash/rinse arms, strainers and if fitted stand pipe.
 - ▶ Open site shut-off valve.
 - ▶ Turn on main switch or insert the plug.
 - ▶ Check level of detergent and rinse aid container.
-

- ▶ Close Door.
- ▶ Push the ON/OFF button.

↳ During automatic filling and heating, the ON/OFF button flashes blue and the fill symbol is illuminated.

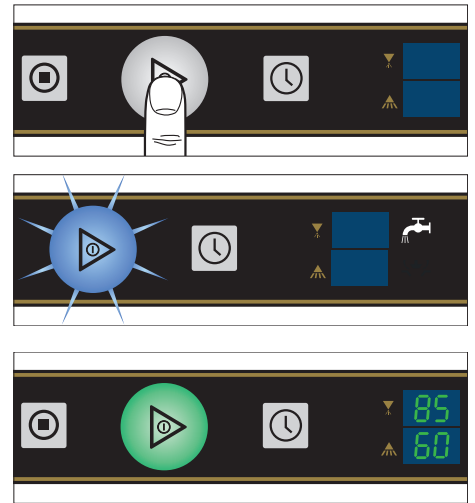

As soon as the machine is ready for operation, the ON/OFF button illuminates green and the fill symbol goes out.

7.3.2 Preparing the washware

- ▶ Remove any food residue.
- ▶ Place wash ware face down in the rack.
- ▶ Rinse off wash ware.

7.4 Displaying and selecting the program

7.4.1 Programme overview

Code	Description
P1	for light dirt deposits
P2	for normal dirt deposits
P3	for heavy dirt deposits
P4 / E	Reduced energy consumption programme for light to normal soil deposits
HY	For hygienic machine cleaning (see chapter 7.9)

7.4.2 Displaying and selecting the program

- ▶ Pressing the programme selection button in standby mode displays the programme currently selected.
- ▶ Pressing the programme selection button again changes the programme on a rolling basis.

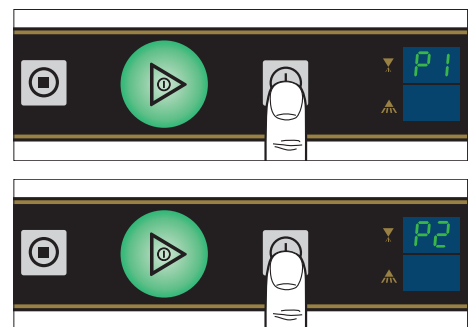

7.5 Washing

- ▶ Machines without dosing unit: Add detergent to the tank.
- ▶ Slide rack into the machine and close the door.
- ▶ Press the ON/OFF key.

↳ The ON/OFF key illuminates blue.

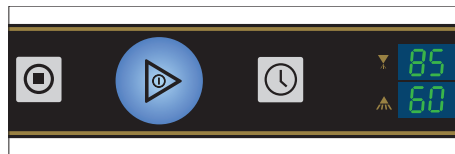
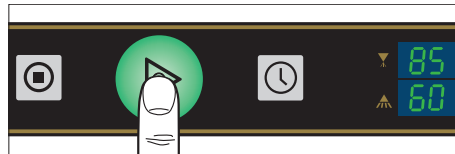

When the programme has finished, the ON/OFF key flashes green.

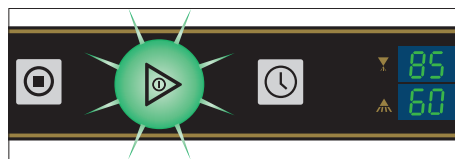

7.6 Switching off the machine

- ▶ Versions with stand pipe: Pull.

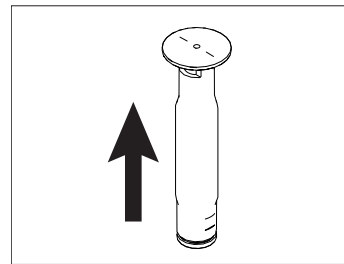

- ▶ Close Door.
- ▶ In standby mode, press the ON/OFF key for 3 seconds.

↳ The ON/OFF key flashes blue, the drain symbol illuminates

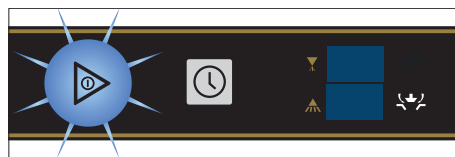
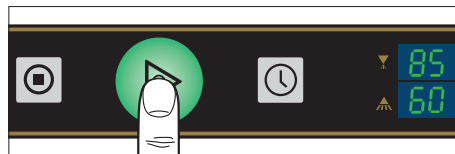

When the drain process is complete, the machine switches off automatically and the key illumination goes out.

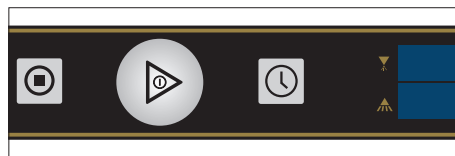

During the drain process, the machine interior is cleaned automatically. Then remove any coarse residues manually.

When the machine has switched off:

- ▶ Turn off main switch or remove the plug.
- ▶ Close on-site shut-off valve.

7.7 Executing daily cleaning

NOTICE!

Property damage

The use of unsuitable agents can cause corrosion or damage to the surfaces.

- ▶ Do not use any chlorine-containing, acidic or metal-containing additives to clean the machine.
- ▶ Do not use metal sponges.

- ▶ Open the door, remove strainer and standpipe if fitted. Rinse under running water. **Make sure that food debris does not enter pump intake!**

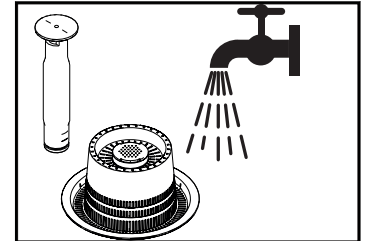

- ▶ Clean machine interior.
- ▶ Replace strainer and stand pipe if necessary.

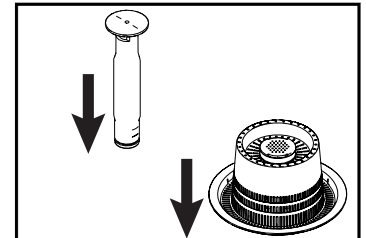

- ▶ Leave the door open for ventilation.

7.8 Executing weekly cleaning

- ▶ Remove and clean all rinse arms on the base and ceiling of the wash chamber. To do this, loosen the knurled nut (A) between the arms and remove both arms. The knurled nut should remain firmly attached to the slotted screw axle (B) in the thinner rinse arm (C). If necessary, hand-tighten the knurled nut on the slotted screw axle.

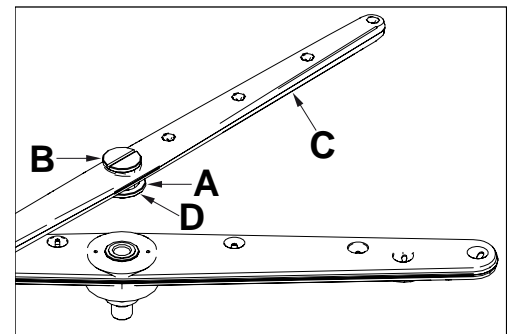

Caution: Do not lose the white Teflon disc (D)!

- ▶ Also clean the arm base and axle on the base and ceiling.
- ▶ Replace all parts.

7.9 Executing hygiene cleaning (only with drain pump)

After reaching a predefined number of rinse cycles, the notice "HY" is shown on the display and the ON/OFF key flashes red/green. This indicates that an automatic hygienic clean of the machine interior should be carried out.

ECOMAX 404 / 504

Settings

- ▶ Before end of operation, remove the rack and place 2 HOBART hygiene tabs in the machine interior (1 tab for model 404).
- ▶ Tap the programme selection key.

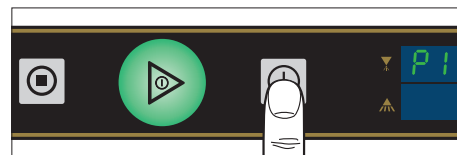

- ▶ Select hygiene programme "HY".

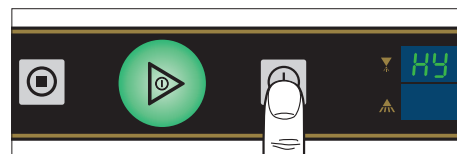

- ▶ Close Door.
- ▶ Press the ON/OFF key.
 - ↳ While the hygiene programme is running (duration approx. 10 minutes), the ON/OFF key illuminates blue.

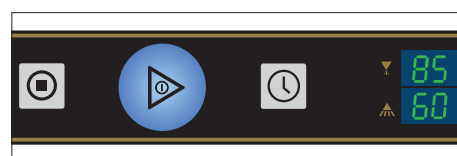

- ↳ Finally, the machine drains and switches off automatically.
- ↳ The key illumination goes out.



If necessary, hygiene cleaning should be carried out before the pre-set number of wash cycles is reached. With regular use, the machine interior will remain free of soil and dirt deposits.

8 Settings

8.1 Overview of operator menu

Menu item	Function
01 Detergent/dosage amount	Setting
02 Rinse aid/dosage amount	Setting
03 Water hardness	Setting
04 Wash cycles	Display
05 Hose filling detergent	For commissioning and replacement of the canister
06 Hose filling rinse aid	For commissioning and replacement of the canister
07 - 10 External water treatment	Reset Remaining capacity Activate/deactivate Output capacity
11 / 12 Temperatures	Standard / Thermolabel 71°
	Display

8.2 Open operator menu and make settings

NOTE: Only possible when the machine is switched off.

To switch the machine off if necessary, press the Stop button.

- ▶ Open Door.
- ▶ Press and hold the Stop button and briefly press the ON/OFF button at the same time.

↳ The first menu item (01) flashes

- ▶ Close Door.

After closing the Door, you can navigate between the menu items. The top line of the display shows the menu number. The bottom line shows the setting value.

- ▶ Pressing the programme selection button opens the next menu item.
- ▶ Pressing the ON/OFF button (3 seconds) activates a menu item. The setting value in the bottom line flashes.
- ▶ You can cancel the setting process by pressing the Stop button.
- ▶ Pressing the Programme Selection button once increases the value. Pressing and holding the Programme Selection button continually increases the value.

- ▶ Pressing the ON/OFF button saves the value.

- ▶ Exit the operator menu by opening the Door or pressing the Stop button.

↳ The machine switches to Off mode.

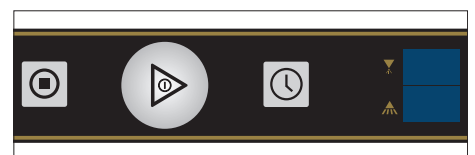
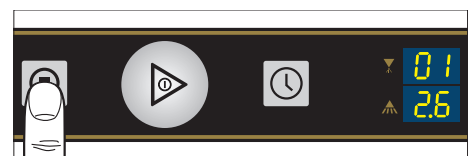
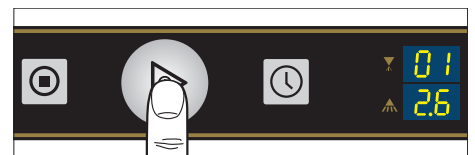
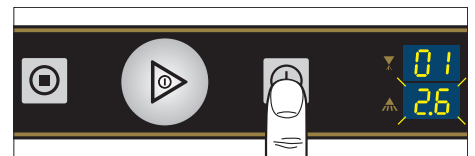
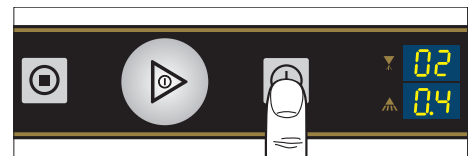
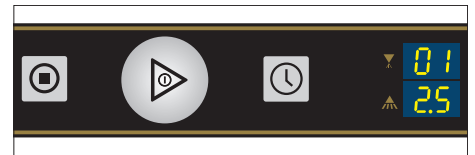
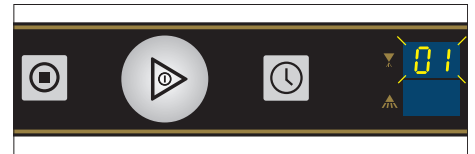
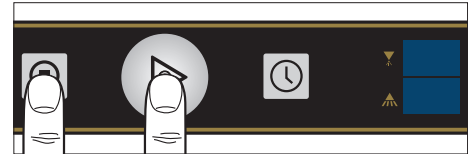
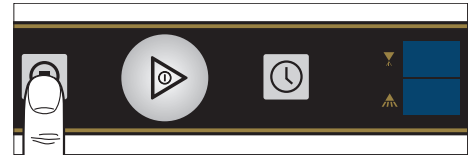

8.3 Detergent/dosage amount

Only relevant for integrated dosing units.

- ▶ Open menu and make settings (see section 8.2).
- ▶ Select menu item "01"

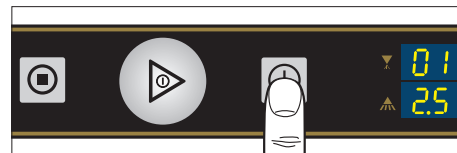

↳ The bottom display shows the current dosage value, default setting: 2.3 g/l

Setting range 0-9.5 g/l

Make and save settings according to the recommendations of the detergent supplier.

8.4 Rinse aid/dosage amount

Only relevant for integrated dosing units.

- ▶ Open menu and make settings (see section 8.2).
- ▶ Select menu item "02"

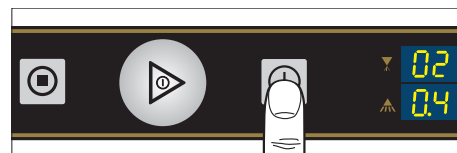

↳ The bottom display shows the current dosage value, default setting: 0.3 g/l.

Setting range 0-2 g/l

Make and save settings according to the instructions of the rinse aid supplier.

8.5 Set water hardness

Only relevant with integrated softener.

NOTE: The softener must be set to the existing water hardness (ask at the local water works).

- ▶ Open menu and make settings (see section 8.2).
- ▶ Select menu item "03"

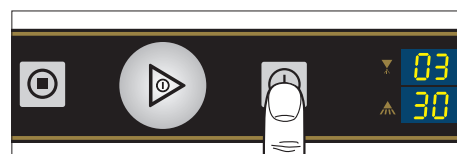

↳ The bottom display indicates the set degree of hardness in °d.

Setting range 1-30

8.6 Wash cycles

- ▶ Open menu (see section 8.2).
- ▶ Select menu item "04"

↳ After activating the menu item with the ON/OFF button, the cycle number is shown as follows (taking 003456 cycles as an example):

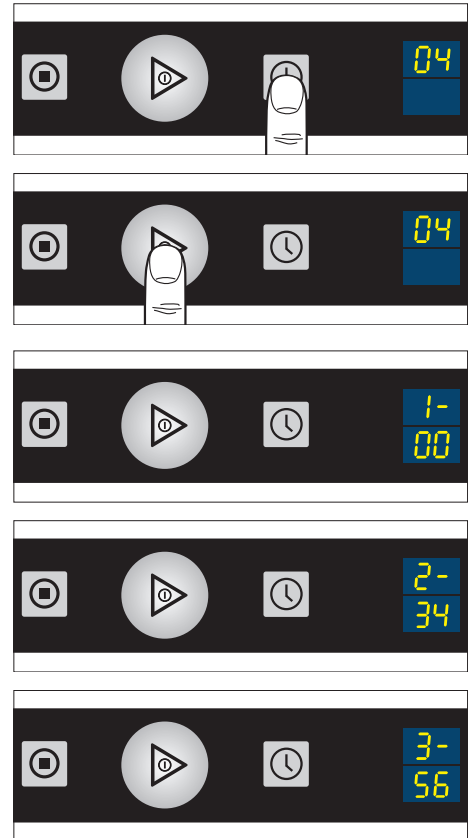

The cycle number is always shown as a 6-place sequence of numbers. First the first 2 places appear on the bottom display on a rolling basis. "1-" appears on the display at the top.

This is followed by the middle 2 places with the display "2-" above.

Finally, the last 2 places are shown with the display "3-" above

8.7 Hose filling detergent

Only relevant for integrated dosing units.

- ▶ Open menu and make settings (see section 8.2).
- ▶ Select menu item "05", bottom display shows "0".

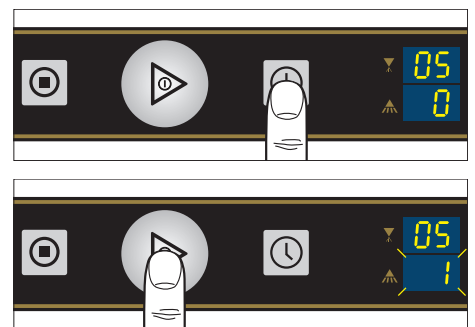

- ▶ Activate the menu item by pressing the ON/OFF button (3 seconds).

↳ The bottom display changes to a flashing "1"

- ▶ Filling does not start until the ON/OFF button is pressed again (~ 95 seconds)

↳ Before the 1, a dot flashes, indicating that the machine is currently filling with detergent

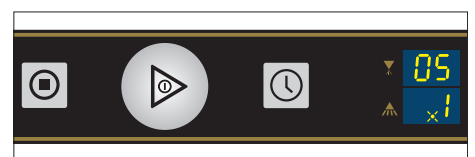

You can cancel ongoing suction by pressing the Abort button

ECOMAX 404 / 504

Settings

There is no need to wait until the end once the filling process has been activated. The filling of the rinse aid hose can also start in parallel.

8.8 Hose filling rinse aid

Only relevant for integrated dosing units.

- ▶ Open menu (see section 8.2).
- ▶ Select menu item "06", bottom display shows "0".

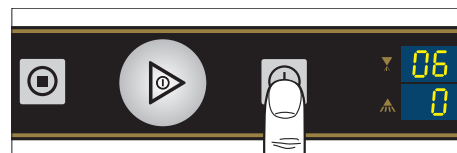

- ▶ Activate the menu item by pressing the ON/OFF button (3 seconds).

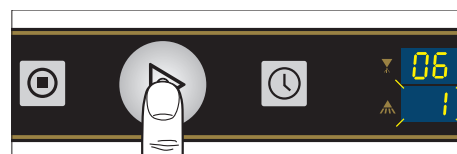

↳ The bottom display changes to a flashing "1"

- ▶ Filling does not start until the ON/OFF button is pressed again (~ 175 seconds)

↳ After the 1, a dot flashes, indicating that the machine is currently filling with rinse aid

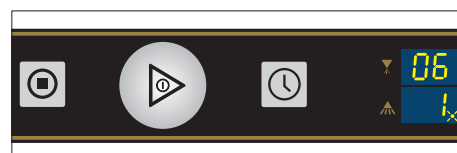

You can cancel ongoing suction by pressing the Abort button

8.9 External water treatment

Relevant only when activated (see section 8.9.3)

This can be used to monitor the capacity of an external water treatment or a pre-filter on the basis of the calculated water flow.

8.9.1 Resetting

Reset the remaining capacity to the output capacity value.

- ▶ Open menu and make settings (see section 8.2).
- ▶ Select menu item "07".

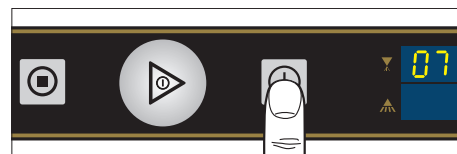

- ▶ After the menu item is activated with the ON/OFF button, a flashing "1" is shown on the bottom display.

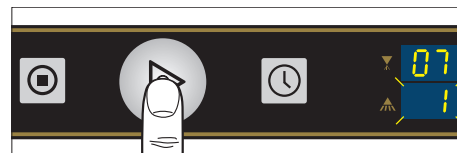

- ▶ Pressing the ON/OFF button again resets the programme.
 - ↳ Flashing stops

8.9.2 Remaining capacity

The remaining capacity counts backwards from the set output capacity value and can be shown as follows:

- ▶ Open menu (see section 8.2).
- ▶ Select menu item "08"

↳ After activating the menu item with the ON/OFF button, the remaining capacity is shown as follows (taking 003456 litres as an example):

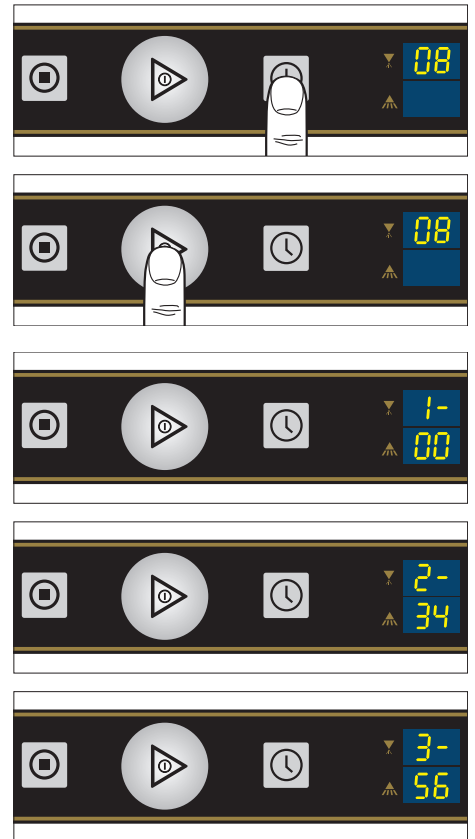

The remaining capacity is always shown as a 6-place sequence of numbers. First the first 2 places appear on the bottom display on a rolling basis. "1-" appears on the display at the top.

This is followed by the middle 2 places with the display "2-" above.

Finally, the last 2 places are shown with the display "3-" above

8.9.3 Activate/deactivate

This must be deactivated to use the capacity monitoring.

- ▶ Open menu and make settings (see section 8.2).
- ▶ Select menu item "09"

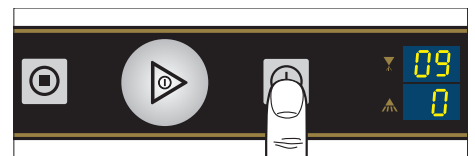

Bottom display shows the current setting:

- "0" = deactivated
- "1" = demineralisation cartridge (assumption: 3 l/min)
- "2" = reverse osmosis system (assumption = 1.5 l/min)

8.9.4 Output capacity

Value is preset to 14000 l.

To display or change:

- ▶ Open menu and make settings (see section 8.2).
- ▶ Select menu item "10"

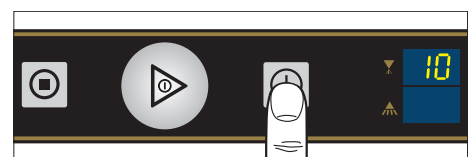

After activating the menu item with the ON/OFF button, the max. 6-place value is shown as follows (taking 014000 litres as an example):

First the first 2 places are shown on the bottom display.

"1-" appears on the display at the top.

- ▶ Change with programme selection button as needed.

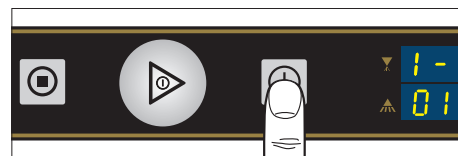

- ▶ The next two places are shown when the ON/OFF button is pressed.

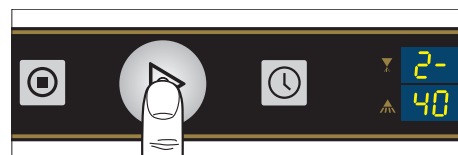

- ▶ Change with programme selection button as needed.
- ▶ The last two places are shown when the ON/OFF button is pressed.

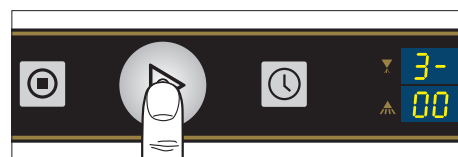

- ▶ Change with programme selection button as needed.
- ▶ Pressing the ON/OFF button again saves a changed value.

8.10 Temperatures

Here, it is possible to change from standard temperatures complying to DIN 10534 to elevated temperatures complying to NSF (Thermolabel 71° C). As a result, the program run times are extended.

- ▶ Open menu and make settings (see section 8.2).
- ▶ Select menu item "11"

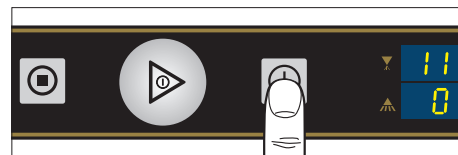

Bottom display shows the current setting:

"0" = standard temperatures

"1" = increased temperatures

8.11 Displaying the temperatures

- ▶ Open menu and make settings (see section 8.2).
- ▶ Select menu item "12"

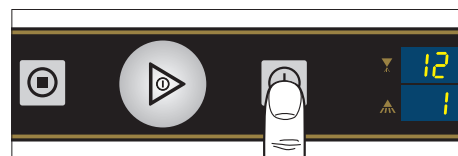

Bottom display shows the current setting:

"0" = no display of temperatures.

"1" = display shows the maximum temperature reached during the last wash programme.

"2" = display shows the current boiler and wash tank temperatures.

9 Display of faults and information

9.1 Information

The On/Off button flashes green/red alternately and the following instructions are shown with a letter combination on the display.

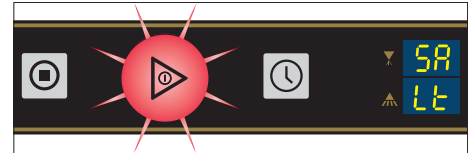

Display	Cause	Remedy
SA Lt	Regenerating salt depleted.	Refill regenerating salt (see section 6.2).
Door	Filling, washing or pump-out programme interrupted	Close Door.
HY	"Carry out hygiene programme" notice	Executing hygiene cleaning (see section 7.9).

9.2 Error

The ON/OFF button illuminates red and "Er" appears on the top display.

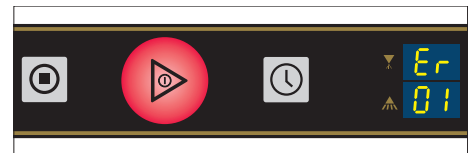

The error code is shown in the bottom display (see table).

Error code	Reason	Remedy
01	Temperature boiler sensor exceeded.	Contact your HOBART Service Partner.
02	Temperature boiler sensor undercut.	Contact your HOBART Service Partner.
03	Boiler thermostop in wash programme.	Contact your HOBART Service Partner.
05	Temperature tank sensor exceeded.	Contact your HOBART Service Partner.
06	Temperature tank sensor undercut.	Contact your HOBART Service Partner.
07	Upper limit of pressure sensor for boiler exceeded.	Contact your HOBART Service Partner.
08	Total value pressure sensor boiler undercut.	Contact your HOBART Service Partner.
09	Total value of pressure sensor for tank exceeded.	Contact your HOBART Service Partner.
10	Total value pressure sensor tank undercut.	Contact your HOBART Service Partner.
12	Water level regulation in wash tank failed.	Contact your HOBART Service Partner.
13	Filling programme monitor pressure sensor tank.	Drain machine.
14	Wash tank draining in pump out programme for tank pressure sensor.	Clean the drain hose if necessary and pump-out the machine again.
17	Filling monitoring by impeller sensor.	Check water supply.
18	Filling monitoring by measuring the water level in the boiler.	Check water supply.
28	Fill level of wash tank too low at programme start.	The machine refills automatically and starts the programme. If the error is permanently displayed, contact your HOBART Service Partner.

Error code	Reason	Remedy
29	Capacity of external water treatment unit depleted.	Replace part or full demineralisation cartridge.
31	Filling monitoring	Check water supply. Contact your HOBART Service Partner.

10 Troubleshooting guide

10.1 Poor wash result

Fault type	Possible cause	Remedy
Wash ware not clean.	Wash arm stiff (must rotate easily by hand).	Remove wash arms and clean them thoroughly. Also check water outlet from machine to wash arm is clear.
	Wash arm nozzles are clogged (visual check).	Remove wash arm, remove cleaning plugs and rinse wash arm thoroughly until all soiling is removed. Replace cleaning plugs.
	Rinse nozzles clogged (usually by lime deposit).	Remove rinse arms and descale them in separate container. Check site softening system for function.
	Detergent concentration is too low or too high.	Check detergent concentration setting.
	Strainer soiled.	Remove, empty and clean strainer.
	Wrong programme selected for heavily soiled wash ware.	Select programme with longer wash cycle.
Wash ware does not dry properly.	Rinse aid dosing too low.	Increase dosage.
	Wash ware still greasy.	Detergent concentration too low: increase dosage. Check if detergent is appropriate. If not, choose a stronger one. Drain contaminated water and refill machine. Improve the preliminary cleaning of the wash ware.
	Rack is not suitable for type of dishes (sloping).	Use appropriate racks to create a sloping position which allows water to drain away from cavities.
	Wash ware remains in the machine too long at the end of wash cycle.	Remove wash ware as soon as cycle is completed to enable it to dry.
Streaks and spots on wash ware.	Rinse aid concentration too high (stripe or bubble formation).	Reduce dosage.

Fault type	Possible cause	Remedy
	Hard water or high mineral content.	Check water quality. Every local water works holds data on the composition of the water they supply and will provide these on request. Reference values: Ideal calcium value: 0 – 3°d (total hardness). Ideal mineral content value: for glasses, max. conductivity 100 µS/cm, for dishes, still viable to max. 400 µS/cm.
	Rack is not suitable for type of dishes (sloping).	Use appropriate racks to create a sloping position which allows water to drain away from cavities.
	Inadequate rinse aid dosing causes stains.	Increase rinse aid dosing.
	Machines with integrated softener: use of wrong salt (e.g. tablets).	Do not use salt tablets.

10.2 Other faults

Fault type	Potential causes	Remedy
Glasses are totally or partially cloudy.	Surface of glasses is rough and porous, this is called glass corrosion.	Use new glasses, this is not caused by a malfunction on the machine.
Glass/dish breakage.	Use of unsuitable dish or glass racks.	Use suitable racks.

11 Maintenance

In order to maintain the warranty, as well as a permanently safe, efficient, and trouble-free operation of the machine(s), the required maintenance must be carried out by authorized service technicians. We therefore recommend the conclusion of an inspection and maintenance contract, which guarantees qualified support by specially trained service technicians according to a time schedule based on the operating conditions.

Genuine spare parts must be used for repairs and wearing part replacements. Wearing parts include dosing hoses, rinse arm bearings, etc. In Germany, your HOBART machines are governed by the Ordinance on Industrial Health and Safety and must be inspected by a qualified electrician in accordance with the intervals specified by the Institute for Work and Health of the German Social Accident Insurance [DGUV V3 (BGV A3)].

ECOMAX 404 / 504

Disposal

12 Disposal

- ▶ The machine operator is responsible for disposing of the machine and its operating materials correctly and in accordance with environmental regulations. Observe the national and local legal provisions and regulations.



13 Product disclaimer

Installations and repairs carried out by non-authorized technicians or using non-genuine spare parts, and any technical alterations to the machine not approved by the manufacturer will invalidate the manufacturer's warranty and product liability.

HOBART reserves the right to make changes or improvements to its products without prior notice.

© HOBART GmbH, Offenburg 2025

14 Conformity



Original

EG-Konformitätserklärung

Declaration of Conformity / Déclaration de Conformité / Declaración de Conformidad / Dichiarazione di conformità / Conformiteitsverklaring / Deklaracja zgodności / Försäkran om överensstämmelse / Uygunluk beyanı / Deklaracija o skladnosti / Izjava o skladnosti / Declaração de Conformidade / Prohlášení o shodě

Die alleinige Verantwortung für die Ausstellung dieser Konformitätserklärung trägt der Hersteller.

This declaration of conformity is issued under the sole responsibility of the manufacturer.
La présente déclaration de conformité est établie sous la seule responsabilité du fabricant.
La presente declaración de conformidad se expide bajo la exclusiva responsabilidad del fabricante.
La presente dichiarazione di conformità è rilasciata sotto la responsabilità esclusiva del fabbricante.
Deze conformiteitsverklaring wordt verstrekt onder volledige verantwoordelijkheid van de fabrikant.
Niniejsza deklaracja zgodności wydana zostaje na wyłączną odpowiedzialność producenta.
Denna försäkran om överensstämmelse utfärdas på tillverkarens eget ansvar.
Bu uygunluk beyanı, tamamen üreticinin sorumluluğuna altında düzenlenmiştir.
Ova izjava o skladnosti izdaje se na isključivo odgovornost proizvođača.
Ta izjava o skladnosti je izdana na lastno odgovornost proizvajalca.
A presente declaração de conformidade é emitida sob a exclusiva responsabilidade do fabricante.
Toto prohlášení o shodě se vydává na výhradní odpovědnost výrobce.

Maschine:	Geschirrspülmaschine / Gläserpülmaschine	Hersteller / Dokumentationsbevollmächtigter:	HOBART GMBH / Verena Wiedenhöfer
Machine:	Dishwasher / Glasswasher	Manufacturer / authorized to compile the technical file:	Robert-Bosch-Straße 17
Machina:	Machine à laver la vaisselle / Lave verres	Fabricant / autorisée à constituer le dossier technique:	77656 Offenburg / Germany
Máquina:	Lavavajillas / Lavavasos	Fabricante / autorizado para unificar la información técnica:	
Macchina:	Lavastoviglie / Lavabicchieri	Fabbricante / Responsabile della documentazione:	
Machina:	Vaatwasmachine / Glazenwasmachine	Fabrikant / Geautoriseerd om de technische documentatie samen te stellen:	
Urządzenie:	Zmywarka do naczyń / Zmywarka do naczyń ze szkła	Producent / autoryzowany przedstawiciel:	
Maschinen:	Diskmaskin / Glasvättmaskin	Tillverkare / behörigt att sammanställa den tekniska filen:	
Makine:	Tezgahalt bulaşık makineleri / Bardak yıkama	Üretici / Dokümantasyon yetkilisi:	
Stroj:	Perilica posuda / Perilica čaša	Proizvođač / ovlašten za sastavljanje tehničkog spisa:	
Stroj:	Stroj za pomivanje posode / Stroj za pomivanje kozarcev	Proizvajalec / pooblaščen za dokumentacijo:	
Máquina:	Máquina lava-loiça / Máquina lava-copos	Fabricante / Responsável pela documentação:	
Stroj:	Myčka na nádobí / Myčka na sklenice	Výrobce / osoba zplnomocněná sestavením dokumentace:	
Model:	Eco-F504 - Serie Eco-G504 - Serie Eco-F404 - Serie Eco-G404 - Serie HOBART-F504 - Serie	PC-F504 - Serie PC-G404 - Serie C-G404 C-F504	Type: FG-16-02 Serial No.: 86 78 XXXXX

Hiermit bestätigen wir, dass die genannte Maschine entsprechend den nachfolgend aufgeführten Normen gefertigt und geprüft worden ist.

Herewith our confirmation that the named machine has been manufactured and tested in accordance with the following standards.
Par la présente, nous déclarons que la machine citée ci-dessus a été fabriquée et testée en conformité aux normes.
Por la siguiente confirmamos que la máquina mencionada ha sido fabricada conforme a las siguientes normas.
Con la presente confermiamo che la macchina indicata è stata costruita in conformità alle norme di seguito riportate.
Hierbij bevestigen wij dat de genoemde machine is gefabriceerd en getest volgens de hiervolgende voorwaarden.
Niniejszym deklarujemy, że wymieniony produkt spełnia wymogi następujących norm.
Härmed bekräftar vi att den namngivna maskinen har tillverkats och testats i enlighet med följande standarder.
Işbu belge ile belirtilen makinenin aşağıda listelenen normlar doğrultusunda hazırlanmış beyan ediyiz.
Ovimе потврђујемо да је горе наведени stroj произведен и тестиран суkladно сједјечим стандардима.
S tem izjavljamo, da je naveden stroj izdelan in preizkušen v skladu s spodaj navedenimi standardi.
Com a presente declaramos que a máquina supracitada foi construída e inspecionada segundo as normas referidas a seguir.
Tímto potvrzujeme, že uvedený stroj byl vyroben a zkontrolován podle následujících norem.

EN 17735:2022
EN IEC 55014-1:2021
EN IEC 55014-2:2021
EN 60335-2-58:2005 + Cor.:2007 + A1:2008 + A11:2010 + A2:2015 + A12:2016
EN IEC 61000-6-2:2019
EN IEC 61000-6-3:2021
EN ISO 12100:2010
EN IEC 63000:2018

Die Maschine stimmt mit den folgenden Richtlinien überein:

The product complies with the following directives:
La machine est conforme aux directives fixées:
La máquina armoniza con las siguientes Directivas:
La macchina è conforme alle direttive seguenti:
Het product voldoet aan de volgende richtlijnen:
Urządzenie spełnia wymogi następujących dyrektyw:
Maskinen oppfyller følgende direktiv:
Makine, aşağıdaki yönetmelikler ile uyumludur:
Ovaj stroj je u skladu sa sјedјечim direktivama:
Stroj ustreza zahtevam sјedјечih direktiv:
A máquina está em conformidade com as seguintes diretivas:
Stroj je v skladu s ustanovenimi následujících směrníc:

2006/42/EG (Maschinenrichtlinie, Machinery-Directive)
2014/30/EU (EMV-Richtlinie, EMC-Directive)
2011/65/EU (RoHS Richtlinie, RoHS Directive)
EnEV SR 730.02 Anhang 2.15 (nur für Schweiz / Switzerland only)

Die Schutzziele der Niederspannungsrichtlinie 2014/35/EU wurden gemäß Anhang I Nr. 1.5.1 der Maschinenrichtlinie 2006/42/EG eingehalten.

Protective Goals of the Low Voltage Directive 2014/35/EU are in compliance with Appendix I No 1.5.1 of the Machinery Directive 2006/42/EC.
Les objectifs de protection de la directive sur les basses tensions 2014/35/UE ont été respectés conforme à l'annexe I Nr. 1.5.1 der de la directive relative aux machines 2006/42/EC.
Directiva de protecciones de baja tensión 2014/35/UE están en acuerdo con el apéndice I No 1.5.1 de la directiva de maquinaria 2006/42/EC.
Gli obiettivi di protezione della direttiva per basse tensioni 2014/35/UE è stata rispettata secondo allegato I n. 1.5.1 della Direttiva per macchine 2006/42/EC.
De veiligheidsdoelstellingen van de laagspanningsrichtlijn 2014/35/UE zijn nageleefd in overeenstemming met nr. 1.5.1 van bijlage I van de machine richtlijn 2006/42/EG.
Produkt spełnia wymogi bezpieczeństwa dyrektywy niskonapięciowej 2014/35/UE, zgodnie z załącznikiem I nr. 1.5.1 dyrektywy maszynowej 2006/42/WE.
Skydds målen i lågspänningsdirektivet 2014/35/UE är i överensstämmelse med bilaga I nr 1.5.1 i maskindirektivet 2006/42/EC.
Alçak Gerilim Yönetmeliği 2014/35/UE'nin koruyucu hedeflerine, Makine Yönetmeliği 2006/42/EC, ek I no. 1.5.1'e göre uyumludur.
Sigurnosni ciljevi direktive o niskom naponu 2014/35/UE udovoljavaju dodatku I br. 1.5.1. Direktive o strojevima 2006/42/EC.
Upoštevanje so zaščitni cilji Direktive o nizki napetosti 2014/35/UE v skladu s priložjo I, št. 1.5.1 Direktive o strojih 2006/42/ES.
Os objetivos de proteção da Diretiva de Baixa Tensão 2014/35/UE foram cumpridos de acordo com o Apêndice I, n.º 1.5.1 da Diretiva de Máquinas 2006/42/EC.
Cile ochrany die niskonapětové směrnice 2014/35/UE byly splněny dle přílohy I č. 1.5.1 směrnice o strojních zařízeních 2006/42/ES.

Bestätigt durch:
Confirmed by:

Offenburg, 07.10.2024

ppa.

Harald Disch
Direktor Produktentwicklung Europa
Director Warewash Engineering Europe



Original

Declaration of Conformity

Authorized to compile the technical file:

HOBART UK
Southgate Way, Orton Southgate,
Peterborough, PE2 6GN, UK

This declaration of conformity is issued under the sole responsibility of the manufacturer.

Machine: Dishwasher (F404/F504) Glasswasher (G404/G504)

Trade mark: HOBART

Model:	Eco-F504 - Serie	PC-F504 - Serie	Type: FG-16-02	Serial No.: 86 78 XXXXX
	Eco-G504 - Serie	PC-G404 - Serie		
	Eco-F404 - Serie	C-G404		
	Eco-G404 - Serie	C-F504		
	HOBART-F504 - Serie			

Herewith our confirmation that the named machine has been manufactured and tested in accordance with the following designated standards.

- BS EN 17735:2022
- BS EN IEC 55014-1:2021
- BS EN IEC 55014-2:2021
- BS EN 60335-2-58:2005+A12:2016
- BS EN IEC 61000-6-2:2019
- BS EN IEC 61000-6-3:2021
- BS EN ISO 12100:2010
- BS EN IEC 63000:2018

The product complies with the following regulations:

- SI 2008/1597 (The Supply of Machinery (Safety) Regulations 2008)
- SI 2016/1091 (The Electromagnetic Compatibility Regulations 2016)
- SI 2012/3032 (The Restriction of the Use of Certain Hazardous Substances in Electrical and Electronic Equipment Regulations 2012)

Protective Goals of the Electrical Equipment (Safety) Regulations 2016 (SI 2016/1101) are in compliance with Appendix I No 1.5.1 of the Supply of Machinery (Safety) Regulations 2008 (SI 2008/1597).

Confirmed by: Offenburg, 07.10.2024

ppa. *Harald Disch*

Harald Disch
Director Warewash Engineering Europe

HOBART GmbH

ecomax by HOBART
Robert-Bosch-Str. 17
77656 Offenburg
Deutschland
Tel.: +49 (0)1803 66 29
Fax: +49 (0)1803 63 29.600-23 19
E-Mail: info@ecomaxbyhobart.de
Internet: www.ecomaxbyhobart.de

HOBART Export

Robert-Bosch-Str. 17
77656 Offenburg
Germany
Phone: +49 (0)781.600-2820
Fax: +49 (0)781.600-2819
E-Mail: info-export@hobart.de
Internet: www.hobart-export.com

Hobart UK.

Southgate Way,
Orton Southgate,
Peterborough
PE2 6GN
United Kingdom
Tel.: +44 (0)844 888 7777
Republic of Ireland: +353 (0)1246 0248
Fax: +44 (0)1733 361 347
E-mail: sales@hobartuk.com
Internet: www.hobartuk.com

Compagnie HOBART SAS

Allée du 1er mai
77183 Croissy Beaubourg
FRANCE
Tel: +33 (0)1 64 11 60 00
Fax: +33 (0)1 64 11 60 10
E-mail: contact@hobart.fr
Internet: www.hobart.fr

Hobart Nederland BV

Pompmolenlaan 12
3447 GK Woerden
Telefoon +31 (0)348 462626
Fax: +31 (0)348 430117
E-mail: info@hobartnederland.nl
Internet: www.hobartnederland.nl

Hobart Foster Belgium bvba/sprl

Industriestraat 6
1910 Kampenhout
Telefoon +32 (0) 16.60.60.40
Fax +32 (0) 16.60.59.88
E-mail: info@hobart.be
Internet: www.hobart.be

Hobart Norge

Gamle Drammenvei 120
N-1363 Høvik
Tlf.: +47-67109800
Fax.: +47-67109801
E-post: post@hobart.no
Hjemmeside: www.hobart.no

Hobart Scandinavia ApS

Håndværkerbyen 27
2670 Greve
Danmark
Tlf.: +45 4390 5012
Fax.: +45 4390 5002
E-mail: salg@hobart.dk
Internet: www.hobart.dk

Hobart Sweden/Finland

Tel: +46 8 584 50 920
E-mail: info@hobart.se
Internet: www.hobart.se

Australia

Hobart Food Equipment
Unit 1 / 2 Picken Street,
Silverwater NSW, 2128
Tel: +61 1800 462 278
Fax: +61 02 9714 0222
E-mail: sales@hobartfood.com.au
Internet: www.hobartfood.com.au

HOBART China

15th Floor, Building A
New Caohejing International Business
Center
391 Gui Ping Road
Shanghai, 200233
Telephone: +86 (0)21 34612000
Fax: +86 (0)21 34617166
Internet: www.hobartchina.com

HOBART Korea LLC

7th Floor, Woonsan Bldg, 108, Bangi-dong
Songpa-gu, Seoul 138-050
Korea
Telephone: +82 2 34 43 69 01
Fax: +82 2 34 43 69 05
E-mail: contact@hobart.co.kr
Internet: www.hobart.co.kr

HOBART (Japan) K.K.

6-16-16 Minami-Oi, Shinagawa-ku,
Tokyo 140-0013
Japan
Telephone: +81 3 5767 8670
Fax: +81 3 5767 8675
E-mail: info@hobart.co.jp
Internet: www.hobart.co.jp

Hobart International (S) Pte Ltd

158, Kallang Way, #06-03/05
Singapore 349245
Telephone: +65 6846 7117
Fax: +65 6846 0991
E-mail: enquiry@hobart.com.sg
Internet: http://www.hobart.com.sg

Hobart Thailand

43 Thai CC Tower Building,
31st FL, Room No. 310-311,
South Sathorn Rd., Yannawa,
Sathorn, Bangkok, 10120
Thailand
Telephone: +66(0)2-675-6279-81
Fax: +66(0)2-675-6282
E-mail: enquiry@hobartthailand.com
Internet: http://www.hobartthailand.com

ITW India Pvt Ltd.

501-502 Vipul Trade Centre
Sector 48 Sohna Road
Gurgaon 122001
Telephone: +91 124 4245430
Fax: +91 124 4245432